

# Luggage System Fitting Instructions - Legend TT & Thunderbird

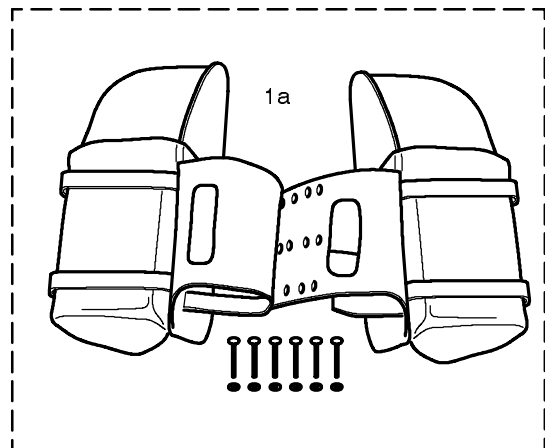

**! WARNING:** Always have Triumph approved parts, accessories and conversions fitted by a trained technician of an authorised Triumph dealer. The fitting of parts, accessories and conversions by a technician who is not of an authorised Triumph dealer may affect the handling, stability or other aspects of the motorcycle operation which may result in an accident causing injury or death.

**! WARNING:** This luggage system is designed for use solely on the Triumph Legend TT and Thunderbird motorcycles and should not be fitted to any other Triumph model or to any motorcycles of other manufacturers. Fitting this luggage system to any other Triumph model or to any motorcycles of other manufacturers may interfere with the rider and could affect the stability and handling of the motorcycle leading to an accident causing injury or death.

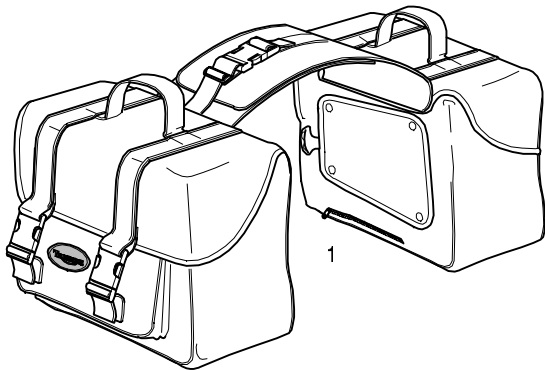

## Parts Supplied

- 1 Nylon Panniers
- 1a Leather Panniers (optional)
- 2 Pannier Rail Right Hand
- 3 Pannier Rail Left Hand
- 4 Bolt M8 (2 off)
- 5 Locknut M8 (2 off)

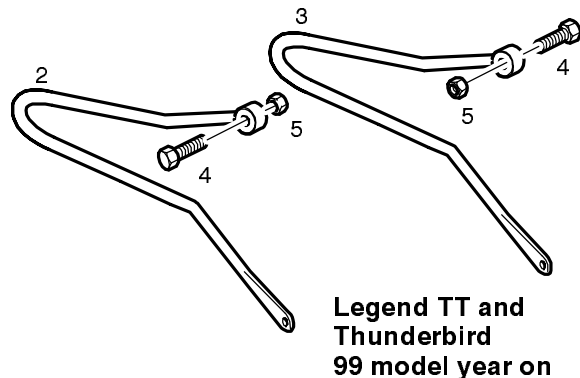
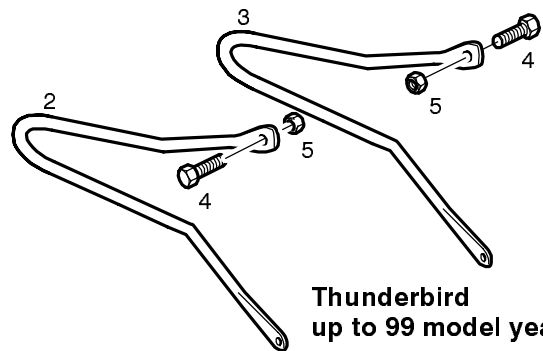

**NOTE:** The pannier rail upper fixing lobes are different for each model of motorcycle. Before commencing the fitting of this luggage system, make sure you have the correct pannier rails for your model of motorcycle.

# Luggage System Fitting Instructions - Legend TT & Thunderbird



**! WARNING:** When fitting this luggage system, ensure the motorcycle is stabilised and adequately supported by a suitable jack placed under the engine, to prevent the risk of injury from the motorcycle falling.

1. Remove the seat.

**NOTE: Nylon Panniers Only.** The nylon panniers have been designed with an optional, quick release method of attachment and may be secured either over, or under the seat.

2. Support the exhaust system and remove the rear footrests securing locknuts.

**! WARNING:** If the engine has recently been running, the exhaust system will be hot. Before working on or near the exhaust system, allow sufficient time for the system to cool, as touching any part of a hot exhaust could cause burn injuries.

3. Using a bolt (4) and locknut (5) from the kit, loosely secure each pannier rail upper mounting to the rear frame, as shown below.

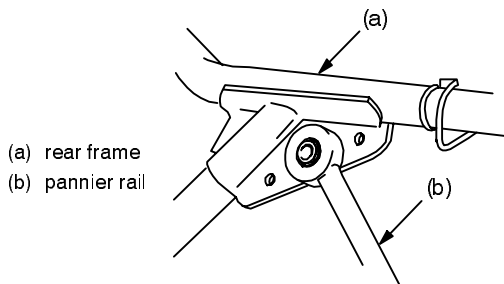

**Pannier Rail Upper Mounting**

4. Locate the pannier rail lower mountings onto the rear footrest studs, as shown below, and secure using the locknuts removed previously. Ensure that the exhaust silencers and mountings are aligned correctly.

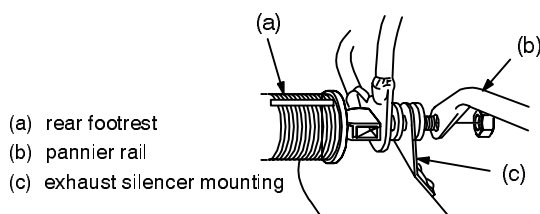

**Pannier Rail Lower Mounting**

5. Tighten the upper pannier rail mounting bolts to 22 Nm and the footrest/exhaust securing locknuts to 27 Nm.

**! WARNING:** Failure to tighten any of the fasteners to the correct specification may result in an accident causing injury or death.

6. Place the panniers over the rear frame as shown below.

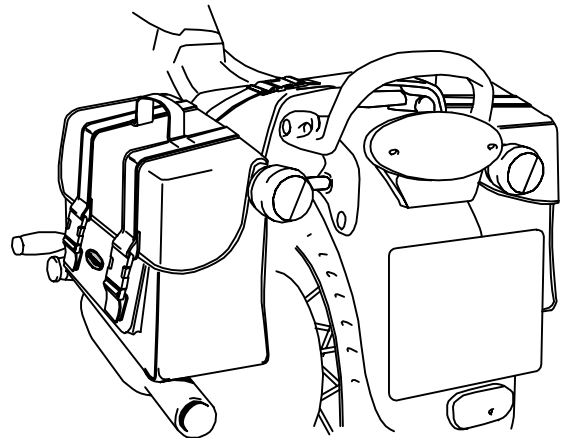

**Pannier Position (permanent)**

**NOTE:** For nylon panniers using the quick release method of attachment, extend the length of the pannier yoke as required to fit over the motorcycle seat.

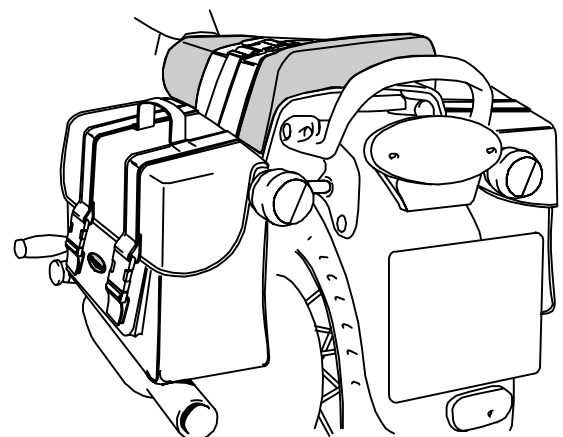

**Pannier Position (quick release)**

7. Secure the panniers to the pannier rails as follows:

### Nylon Panniers

Fasten the panniers to the pannier rails using the Velcro/press-stud flaps, as shown below, and adjust the length of the pannier yoke, as required, to secure the panniers either over the frame or over the seat.

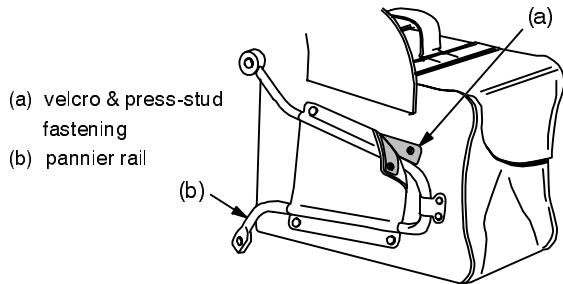

### Leather Panniers

#### Assembly

8. Join the panniers as follows. Align the six holes in the joining strap of the right-hand pannier with the inner six holes in the joining strap of the left-hand pannier (i.e the most narrow assembly possible using two rows of rivet holes).

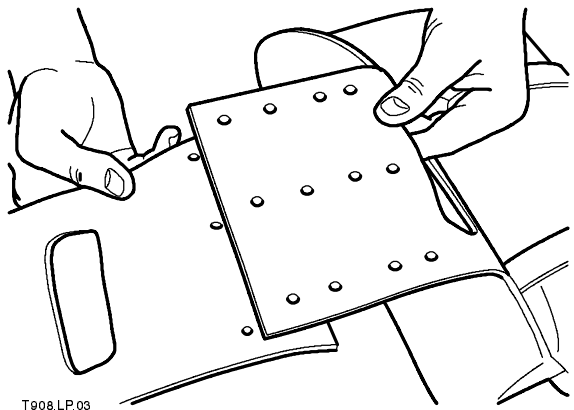

9. With the holes correct aligned, insert the six plastic rivets through the holes from underneath and slide a clip onto each rivet.

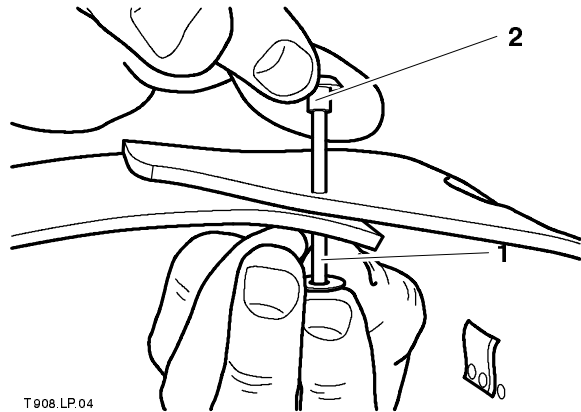

#### 1. Plastic rivet

#### 2. Clip

10. Secure all six rivets using a pop rivet gun.

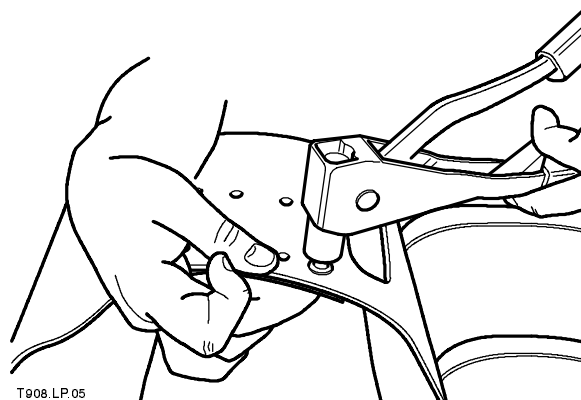

# Luggage System Fitting Instructions - Legend TT & Thunderbird



11. Position the retaining straps as appropriate for the model of motorcycle and securely fasten to each pannier rail, as shown below.

**NOTE:**

Only two straps are required for each pannier

**Thunderbird up to 99 model year**

- (a) retaining straps
- (b) pannier rail

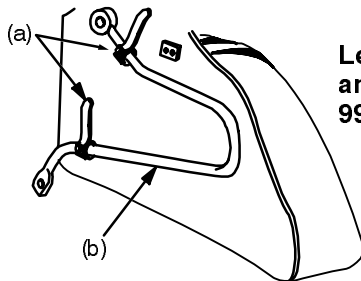
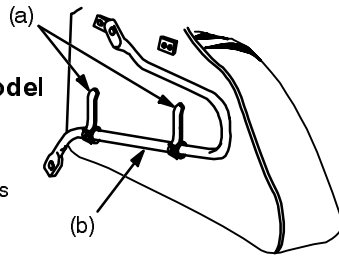

**Legend TT and Thunderbird 99 model year on**

**WARNING:** Failure to securely fasten the straps/flaps to each pannier rail may cause the motorcycle to become unstable leading to loss of control and an accident.

12. Refit the seat.

**WARNING:** Never use a luggage system that is not fitted with a warning label. Failure to fit a warning label may lead to incorrect loading of the luggage system causing instability, loss of control and an accident.

**WARNING:** The maximum safe load for each pannier is 3 Kg (6.6 lbs). Never exceed this loading limit as this may cause the motorcycle to become unstable leading to loss of control and an accident.

**WARNING:** In all cases, loads must be evenly distributed on both sides of the motorcycle. Uneven loading may cause instability, loss of control and an accident.

**WARNING:** After fitting the luggage system, operate the motorcycle in a safe area free from traffic to gain familiarity with the new handling characteristics. Operation when not familiar with the new characteristics of the motorcycle may result in an accident causing injury or death.

**WARNING:** Never ride in excess of 80mph on a motorcycle that is equipped with a Triumph luggage system. The presence of such a luggage system will affect the stability and handling of the motorcycle. Any such changes in stability may lead to loss of control and an accident.

**WARNING:** The motorcycle must not be operated above the legal road speed limit except in closed course conditions.

## Product Care

**Leather Panniers.** This product has been hand made using the finest leather and accessories. To maintain the quality and life of this product, we advise using only a natural leather cleaner. If the article becomes wet, wipe with a cloth and allow to dry naturally.

**Nylon Panniers.** Clean with a damp cloth. Heavy soiling can be removed using a mild detergent. Do not use thinners or any other form of solvent as this may damage the nylon and impair its waterproof qualities.